

The purpose of this manual is to explain how to install and maintain the Electro-Mech Model LX6360 Outdoor Multi-Sport scoreboard as well as the LX6360-ETN version of this product, which features Electronic Team Names. Operation of the scoreboard is covered in the manual that ships with the control console.

## TABLE OF CONTENTS

Best Practices for Personal Safety and Product Care .....	3
Product Specifications .....	5
Planning Your Scoreboard Installation .....	8
Mechanical Installation .....	10
Electrical Installation.....	16
Testing, Operation, and Ongoing Care.....	24
Maintenance.....	25
Limited Warranty Statement.....	31

---

## BEST PRACTICES FOR PERSONAL SAFETY AND PRODUCT CARE

Thank you for choosing Electro-Mech products for your athletic facility. We hope you will be pleased with the performance and appearance of your scoreboard. The information in this document will help you maintain the equipment in its best condition.

### Receiving Your Scoreboard

Depending on the shipping method, cardboard sheets, a partially open wooden crate, or a complete enclosure may protect the scoreboard cabinet. It is important to inspect the scoreboard packaging for damage when it arrives — *before signing any paperwork telling the trucking company that you have received everything in good condition*. If damage has occurred to the packaging, then damage may have occurred to the scoreboard. Where you find dents, scrapes, or holes in the packaging, peel back the cardboard or other packing materials to expose the scoreboard cabinet. Make notes on the paperwork provided by the trucking company before accepting delivery. If the damage appears to be severe, refuse the shipment. Contact Electro-Mech as soon as possible if you suspect shipping damage.

For larger scoreboards (and any separate ID panels that may have shipped with them), we supply eye bolts in the top of the cabinets for lifting. These eye bolts usually remain exposed while the scoreboard is in its shipping package. You may lift the packaged cabinet by the eye bolts to remove it from the truck and move it around prior to installation. You may also transport the cabinet on dollies. For any cabinetry more than twelve feet wide, we recommend using a dolly at least every ten feet along the bottom to provide support and prevent sagging.

We recommend keeping the scoreboard display in its packing materials until the day of installation. It is important to keep the packing materials dry while they are on the scoreboard. Wet cardboard can adhere to the scoreboard face and damage the finish.

If your scoreboard cabinet arrives in a wooden crate, take care to avoid scraping the cabinet with tools, nails, or lumber when prying apart the nailed sections. Make certain to pry the wooden pieces apart from each other rather than trying to apply force against the scoreboard cabinet. Aluminum is strong, but a steel crowbar is stronger.

Once the crate is out of the way, remove the cardboard padding. You may need to remove a few labels adhered to the side of the cabinet for shipping. At this point, your scoreboard cabinet is unpacked and ready for installation.

## Storage Prior to Installation

Unless you are planning to install your scoreboard on the same day that it arrives, you will need to prepare a clean, dry, secure area for storage. Even though your scoreboard display is designed for outdoor use, you will need to keep it away from rain, dirt, accidental damage, and abuse. As an example of why this is important, outdoor scoreboard cabinets include drain holes along the bottom. These drain holes will likely become clogged with dirt if the scoreboard is stored on the ground, especially in the rain.

Stand the scoreboard cabinet upright prior to assembly; never lay it facing up or down. Never stack things on top of the scoreboard cabinet while it is in storage.

These recommendations apply equally to ID panels and other items that may have shipped with your scoreboard.

## Conditions of Installation and Use for Outdoor Scoreboards

This scoreboard display is designed for installation and use in a wet environment. That is, rain and other common weather conditions will not hinder the operation of this product when it is installed correctly. The scoreboard cabinet is not watertight. Instead, it is designed to withstand normal outdoor conditions by routing water through the cabinet and out of drain holes in the bottom. Do not block the drain holes. If the scoreboard is to be installed immediately above something — for instance, an ID panel or the ledge of a wall — please allow 1/4-inch or more clearance below the cabinet. Alternatively, you could provide matching drain holes in the top of the object below the scoreboard.

Outdoor scoreboard displays are typically installed on steel posts. It is important to properly install these posts and allow concrete footings time to cure before using them to support the scoreboard cabinet.

When the scoreboard display is not in use, disconnect it from power. We recommend installing a disconnect switch on one of the mounting posts beneath the scoreboard display. In the "off" position, the switch should isolate all load-carrying conductors (not the ground). This will help protect the scoreboard electronics from nearby lightning strikes and other power fluctuations that might otherwise travel along the power cables.

## PRODUCT SPECIFICATIONS

### **General Description:**

- Model LX6360 is an electronic scoreboard designed for permanent installation outdoors and intended to display time and scoring information for a variety of sports.

### **Standard Package Includes:**

- One scoreboard cabinet
- Four mounting clamp assemblies
- One control console
- One stereo patch cable
- One junction box (when configured to use hardwired data cable)

### **Cabinet Dimensions and Weight:**

- 16 ft (W) x 5 ft (H) x 6 in (D), 250 lb

### **Cabinet Construction and Finish:**

- The cabinet includes a self-supporting frame constructed from extruded aluminum channel and formed aluminum pieces. The face and back sections are made from aluminum sheet material, as are the masks protecting the illuminated digits and other lighted elements. Mask and face pieces are finished with enamel paint. All other cabinet surfaces are mill finish. Captions, optional accent striping, and other decorative elements are cut from exterior grade vinyl. Electro-Mech offers eighteen standard paint and vinyl colors. Other color options are available as an upgrade.

### **Overview of LED Display Circuit Boards:**

- Red or amber LEDs (light emitting diodes) mounted on PCBs (printed circuit boards) form all lighted digits and text elements. The color choice is determined at the time of purchase. All illuminated PCBs include conformal coating for weather protection. These circuit boards are mounted behind aluminum masks, painted black to increase contrast. The masks allow the epoxy shells of the LEDs to protrude past the scoreboard face, maximizing viewing angle while providing impact-absorbing protection from contact with stray balls and other flying objects. The LEDs may be dimmed to reduce glare during night games. They are rated for 100,000 hours of use.

**Display Features:**

- 4-Digit Period Clock, 24 inches tall, shows Time in MM:SS up to 99:59, counts up or down, can show Tenths of Seconds during the final minute of a down-counting Period, can show HH:MM in Time of Day Mode, can show a Segment Clock in Practice Segment Timer Mode
- 2-Digit Scores (one set for Guest, one set for Home), 24 inches tall, to 99
- 1-Digit Period, 18 inches tall, to 4
- Optional Electronic Team Names (one ETN section for Guest, one ETN section for Home), 9x56 pixels, 7-inch x 47-inch active display area, capable of showing up to 11 characters

**Additional Standard Scoreboard Features:**

- Internally mounted horn
- All serviceable components accessible from the front of the cabinet
- Eye bolts for lifting
- Integrated mounting points

**Control Console:**

- The console includes custom software running on an internal microprocessor, a 32-character LCD display, a 37-button sealed membrane keypad, and a 6-ft. power cord. The console enclosure consists of an ABS plastic base and top with a metal back plate.
- Four data output ports can each directly drive a scoreboard display through a single cable run and indirectly drive up to ten displays in perfect synchronization via daisy chaining. The number of synchronized displays is practically limitless when using the optional ScoreLink RF communications system.
- The software includes support for Electronic Team Names, Practice Segment Timer Mode, 50 levels of brightness, and other features.

**Optional Equipment and Features:**

- Data cable for hard-wired installations
- ScoreLink RF communications system for wireless data transmission
- Hard carrying case for control console and accessories
- Non-illuminated, illuminated, and fully electronic ID panels, message centers, and video displays
- Stadium Sound Systems

**Power Requirements:**

- Without ETNs, the LX6360 scoreboard display requires one circuit providing 1.5 amps, 120 VAC, 60 Hz.
- LX6360-ETN requires one circuit providing 3.8 amps, 120 VAC, 60 Hz.
- The control console requires one circuit providing 0.5 amps, 120 VAC, 60 Hz via a standard (NEMA 5-15R) power receptacle.
- Electro-Mech recommends installing a dedicated breaker to control power to the scoreboard display.
- The scoreboard cabinet must be properly grounded.

**Mounting Requirements:**

- In its standard configuration, this scoreboard display is designed to be mounted on two posts positioned ten feet apart, center-to-center.
- The cross-section dimension (width and depth) of each post should not exceed 7-1/2 inches.
- The mounting clamps provided with this scoreboard allow the cabinets to be attached to properly sized and positioned posts without the need for welding, drilling, or fabricating brackets on site.

**Safety Listing, Support, and Warranty Information:**

- All LX-series scoreboard displays are ETL Listed to UL Standard 48 for Electric Signs.
- Electro-Mech offers technical support at no charge over the phone or via the Internet for the life of the product.
- The standard limited warranty covers factory labor on parts returned to Electro-Mech within five years of the scoreboard's date of invoice.
- Additional support plans are available.
- The complete standard warranty statement is included near the end of this document available.

## PLANNING YOUR SCOREBOARD INSTALLATION

A good plan is important to the success of any project, and installing a scoreboard is no exception. An important first step in planning for your scoreboard is determining its optimal location. Key factors here are visibility and accessibility.

By "accessibility" we mean the ease with which you can get people, equipment, cabling, etc. to a scoreboard display during installation, as well as ease-of-access for future service. Positioning the display on a tall, steep embankment or backed up against a densely wooded area can add cost to installations as well as service calls.

By "visibility" we mean the ease with which spectators, participants, and the scoreboard operator can see the display. Because every playing field is unique, there is no one-size-fits-all way to describe the perfect scoreboard location. But we can tell you that, in the United States, your best bet is to put the scoreboard display on the South or West side of the field (facing North or East). This will reduce glare from the setting sun during afternoon games. For other locations, the more general version of this advice: Avoid facing the sun.

### Choosing a Direction



Unless you've selected a very small scoreboard for a very large field, viewing distance is not usually an issue. The rule of thumb in the sign industry is that, for lighted characters, every inch of height provides 50 feet of viewing distance. For comfort, and because you also need to read the captions on a scoreboard, we prefer to recommend 25 feet of viewing distance per inch of digit height. Model LX6360 uses 24- and 18-inch tall digits, meaning it can easily be seen from 450 feet. If players or spectators will be further from the scoreboard, your field may require a larger display.

The height of the scoreboard display above the ground is important for several reasons. For safety, you do not want to position any sign where people are likely to smack their heads into it. Also, when they are easily within reach, the power and other cables running into the cabinet can prove tempting to bothersome hands. For these reasons, as well as visibility above players on the field, you should usually keep the bottom of the scoreboard display at least eight feet above ground level. While there is theoretically no upper limit on the height, you must consider stability of your structure and serviceability. In other words, the taller the sign, the larger the posts and footings will need to be. And, the taller the sign, the more difficult it will be to service.

Other factors, such as the availability of power or the nature of the terrain (too rocky or too swampy), can play a role in determining scoreboard display location. When in doubt, feel free to discuss options with your scoreboard sales rep.



The sections that follow in this document discuss the details of mechanical and electrical installation of a single scoreboard display. If your project includes multiple scoreboards or other electronic displays, please check with your scoreboard sales rep to make sure you have any project-level documentation you may need.

### **Before You Spend Your Time and Money...**

Please keep in mind that the dimensions and other details referenced throughout this document are specific to the standard configuration of this particular scoreboard model. Before purchasing materials, digging holes, etc. you should verify with the factory that you have the right documentation for your unique project.

It is possible that a government agency, such as your local city council, will require a building permit or other documentation and approval forms related to the installation and operation of your scoreboard. In some cases, particularly in coastal regions where hurricanes are a concern, the installation plan may require a stamp from a locally licensed Professional Engineer (P.E.).

## MECHANICAL INSTALLATION

This section of the manual describes installing the scoreboard display, in its standard configuration, on posts. If your scoreboard project includes customizations with additional ID panels or requires special mounting considerations, please contact Electro-Mech to request details specific to your project. If you have an existing structure and would like to change the position or size of our mounting hardware to accommodate it, we can probably help you out. But we need to find out BEFORE we start building the cabinet. Let your scoreboard sales rep know about any special requirements as early in the process as possible.

### **Additional Materials and Tools**

All permanently installed scoreboard displays are attached to some sort of structure. It is beyond the scope of this document to provide detailed instructions on the wide variety of tools and techniques available to build a sign support structure. In most cases involving outdoor scoreboard displays, the structure consists of two or more steel posts, each set in a concrete footing. What follows assumes this type of structure. This document also assumes the installer has access to tools and skills for...

- Digging holes for footings
- Mixing and pouring concrete
- Lifting posts into position
- Keeping the posts aligned until the concrete sets
- Lifting the scoreboard cabinets

Electro-Mech recommends you find a reputable sign installer with the equipment and experience to handle the work mentioned above. If you are unfamiliar with sign installers in your area, contact your scoreboard sales rep for recommendations.

Other than the equipment and materials outlined above, the main items required to complete the mechanical installation are...

- Two posts
- A 3/4-inch SAE wrench or socket set to tighten the clamps

## Types of Posts

Here are some good choices for posts:

- **6-inch Schedule 40 steel pipe**  
(actual outer diameter is 6.63 inches)
- **W6x25 I-beam**  
(width=6.08 inches, depth=6.38 inches)
- **7-inch square (or box) tube**  
with a minimum of 1/4-inch thick walls

The shape and material of the posts is important only in the sense that the posts must be strong enough to support the load they will carry. Other than this general condition, the main limit imposed by the scoreboard is that the posts have to fit inside the mounting clamps (assuming you wish to use the hardware provided by Electro-Mech). The standard clamps form a "pocket" that is 7-1/2 inches square. So, if you try to use a 10-inch diameter pipe, our clamps will not work.

### Mounting Clamp Assembly



## Mounting Clamps

Model LX6360 ships with four Mounting Clamp Assemblies — possibly more, if there are additional ID panels or other customizations. Each assembly consists of an Angle Bracket, two Washers, two Nuts, and two Threaded rods. The pieces fit together as shown in the diagram above.

### Overhead Cross-Section View of a Mounting Clamp Assembly on a Typical Post

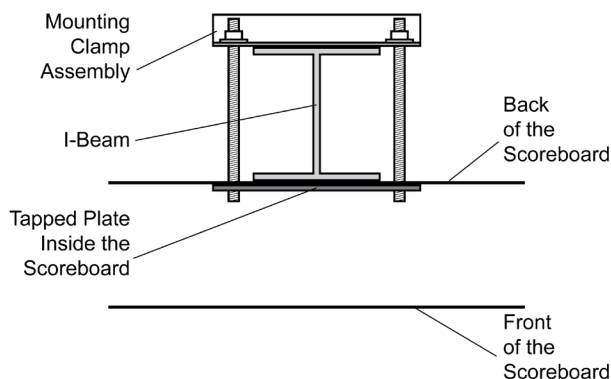

Each Mounting Clamp Assembly mates with a Mounting Point on the back of the scoreboard cabinet. These Mounting Points consist of tapped steel plates riveted inside the cabinet along the top and bottom frame pieces. The idea is to sandwich a post between the back of the cabinet and the angle bracket of the Mounting Clamp Assembly. When you tighten the nuts against the angle bracket, you clamp the scoreboard display to the post. Using the standard mounting clamps provided with the scoreboard, you can

mount the cabinet(s) on posts without having to cut or drill any metal parts and without having to weld pieces together.

## Post Length and Footings



The length of your posts is determined by the configuration of your scoreboard display, its height above the ground, and the depth of your footings. Footing size is also related to the cabinet height and configuration. To some degree, the depth of the footings will be determined by the equipment available to the installer. In general, a smaller diameter hole needs to go deeper than a larger diameter hole. The trick is to create footings hefty enough to provide stability for the sign structure.

Two- or three-foot diameter footings are typical for a scoreboard of this size. A good rule of thumb for estimating the depth of such a footing is to have one third of the post in the ground. For example, assume you want to position the bottom of the scoreboard display eight feet above the ground, and assume your cabinet height includes an ID panel which brings the total to eight feet. That gives you sixteen feet of structure height above the ground. So, you could estimate that a minimum of eight feet of each post should be in the ground. Thus each post would need to be at least 24 feet long. Allowing for six inches of concrete below the bottom of the posts, the footing depth would be 8-1/2 feet.

In some locations, building requirements may dictate that footing design and pole selection require "stamped" drawings from a Professional Engineer (P.E.) licensed to operate in the area.

A Professional Engineer will be familiar with local requirements concerning wind loads and other factors that may affect the size, position, and number of posts and footings. Your Electro-Mech sales rep can work with you to meet any special needs that arise from the a Professional Engineer's design work, as long as we are aware of those needs BEFORE the scoreboard goes into production. It is always best to consult with your local building authorities and a local sign installer before finalizing the details of an installation.

## Position of Posts and Footings

In its standard configuration, this scoreboard display mounts on two posts. Each post is attached to the back of the scoreboard at pre-determined points. The diagrams below show the center-to-center spacing for the posts and their footings. If your scoreboard package has been customized, these measurements may not apply.

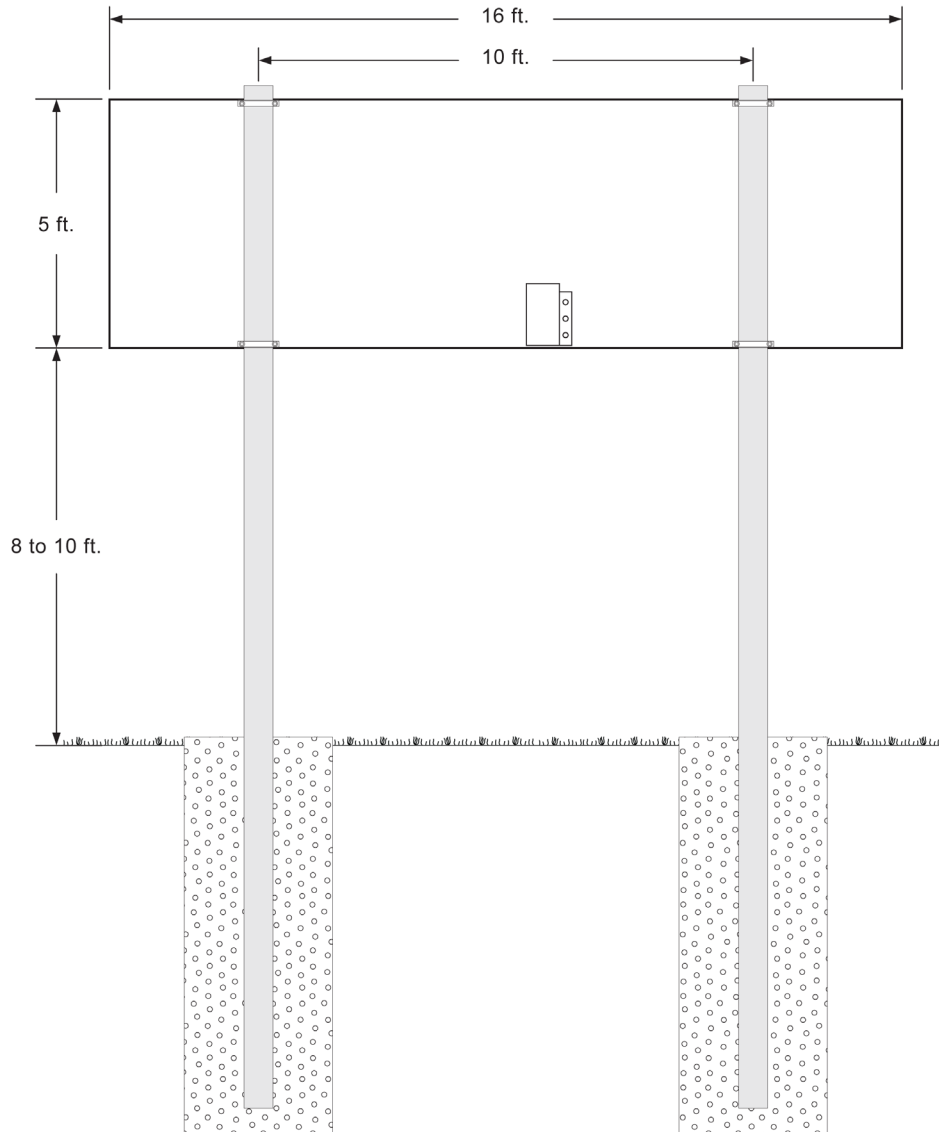

Once you have verified the positions of the posts and the size of the footings, you are ready to dig your holes, pour your concrete, and set your posts. There are several techniques for ensuring proper alignment of the posts. Typically installers will construct a temporary wooden support frame to hold each post in place while the concrete sets. Having plumb posts in the proper position is the key to a smooth mechanical installation.

## Attaching the Scoreboard Display to the Posts

After the concrete sets, you should clamp the scoreboard display and ID panels to the posts using the mounting clamps provided by Electro-Mech. Most sign installers use a crane or some other type of hoist system to raise the cabinets into position. A typical installation goes like this:

1. Begin with the bottom cabinet piece.
2. Rest the cabinet on the ground with its back to the posts.
3. Align the mounting points with the posts.
4. Thread the rods into the tapped holes in the back of the cabinet.
5. Slide the angle bracket over the rods at each mounting point.
6. Slide a washer onto each rod (behind the angle bracket).
7. Loosely install the nuts.
8. Raise the cabinet into position on the posts.
9. Tighten the nuts so that the cabinet is secure.
10. Remove the eye bolts from the top of the cabinet.
11. Set the next cabinet on top of the this cabinet.
12. Repeat steps 3 through 7.
13. Raise the cabinet slightly – leaving a 1/4-inch gap between cabinets for drainage.
14. Tighten the nuts so that the cabinet is secure.
15. If there are additional cabinets, remove the eye bolts from the previous cabinet and repeat the steps 11 through 14.

For smaller installations, a few willing volunteers can lift each cabinet and hold it while someone else tightens the clamps. When using this approach, it is best to start with the top cabinet and work your way down.

Electro-Mech provides eye bolts in the tops of the cabinets so that you may lift them with a crane. Use a spreader bar to prevent ropes or cables from pulling on the eye bolts at an angle of less than 45 degrees from horizontal. The more force applied horizontally, the more likely the eye bolts will bend. After a cabinet is securely mounted to the posts, you may remove its eye bolts and dispose of them.

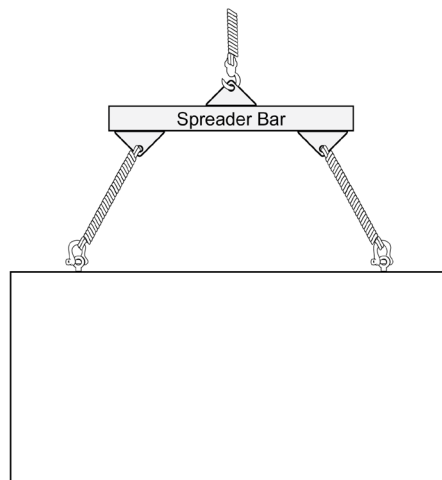

A few tips about what NOT to do when installing a scoreboard display:

- Don't move scoreboard cabinets around by lifting them with a forklift, on a single dolly, or in other ways that concentrate all weight on one spot. This can cause the cabinet to sag.
- Don't attempt to clamp the posts to the scoreboard display and THEN raise the structure into place. The scoreboard is not designed to support the weight of steel pipes or I-beams. Lifting a scoreboard cabinet with posts attached is likely to warp it.
- Don't try to bolt various cabinets together and lift them. This is another path to a warped scoreboard display.
- Don't hang cabinets before your concrete footings have time to cure.
- Don't mount the scoreboard display at a height (or in a location) where people are likely to bump their heads on it or be tempted to bother the cabling.
- Don't block the drain holes.
- Don't walk away from the project without installing a ground rod.

## ELECTRICAL INSTALLATION

This section of the manual describes hooking up power and data cable. If your scoreboard package includes special accessories such as a Stadium Sound System or Video Display, there may be additional cabling and conduit needed to support this equipment. Please consult the documentation provided with these items.

For the standard configuration of LX6360, power cable and any other external connections enter through openings in the back of the cabinet. If your facility requires access via some other means — for instance, if you need to mount this display on a wall — we can provide other options for cable routing. Let your scoreboard sales rep know about any special requirements BEFORE we begin building your scoreboard display.





## Power Considerations

All permanently installed scoreboard displays require a 120 VAC 60 Hz power source. This AC power may come from an inverter attached to a battery charged by solar energy, a gasoline powered generator, or the local power company. It is beyond the scope of this document to consider all the possible variations. We will be concerned here with only the last few feet the power cable will travel as it enters the scoreboard cabinet.

Model LX6360 Soccer scoreboard display draws a maximum of 3.8 amps when the package includes Electronic Team Names. Without ETNs, the maximum current is 1.5 amps. Make sure your power system can supply this load and that your power cable is rated to support the load over the distance it must travel. We recommend running power cable in conduit wherever it would otherwise be exposed. Never run power and data cables in the same conduit. If you run your cables underground, maintain at least twelve inches distance between power and data cables.

## Additional Materials and Tools

The main items required to complete the electrical installation are...

- A ground rod kit (and a mallet to drive the rod into the ground)
- Power cable (typically 12 AWG)
- A disconnect switch and weather-tight enclosure
- A convenience receptacle (optional)
- Data cable (unless you've purchased a ScoreLink wireless data system)
- Wire splicing kit for use with 22 AWG wire (if data cable is used)
- Conduit, fittings, and tools for cutting and bending the conduit
- Crimp terminals and crimping tools, including wire strippers
- 1/4-inch hex nut driver
- Common tools such as Phillips and flat head screwdrivers, a knife, etc.

This document assumes the installer has access to tools and skills for...

- Working with conduit and fittings
- Routing cables
- Trenching
- Crimping terminals, splicing, soldering, and other basic wire management
- Minor carpentry work

Electro-Mech recommends you find a reputable sign installer or electrician with the tools and experience to handle the type of work mentioned above. If you are unfamiliar with sign installers in your area, contact your scoreboard sales rep for recommendations.

## Step-by-Step Guide to Connections at the Scoreboard Display

Step 1: Run the power and data cables.

As mentioned on the previous page, the scoreboard display requires AC power. And, unless you have purchased the ScoreLink wireless data communication package, you will need to run data cable from the point of operation (usually the press box) to the display. We cannot give a full blown tutorial on trenching and other techniques for running cabling, but we can provide a few tips.

- Electro-Mech can supply burial quality data cable.
- If you run data and power cables in the same trench, keep them separated by at least twelve inches of dirt.
- Use conduit to protect your cables wherever they would otherwise be exposed.
- The knockouts in the back of the scoreboard cabinet allow fittings for 1/2-inch or 3/4-inch conduit to tie directly to the back of the display.
- Consider using conduit even for underground sections of your cable runs to provide added protection and ease of access if the cable needs to be replaced in the future.
- Don't run power and data cables in the same conduit.
- If you are running data cable to multiple scoreboard displays, you should never split the signal; either use additional outputs on the control console for secondary runs, or daisy-chain from one display to the next.

Step 2: Install the disconnect switch (and, optionally, a convenience receptacle).

The National Electric Code (Article 600.6) requires a disconnect switch for any electric sign. Typically the disconnect switch is installed on one of the posts supporting the scoreboard display. Since scoreboards are often installed away from buildings and other structures likely to contain power receptacles, it is a good idea to install a convenience receptacle in line with the disconnect switch. You won't need the receptacle for normal scoreboard operation, but it may come in handy for plugging in tools during installation or later in the life of the display.



**Step 3: Remove the access panel.**

There is an access panel on the back side of the scoreboard cabinet. The cover is held in place by several sheet metal screws. Use a 1/4-inch nut driver to remove these screws. Set the access panel and screws aside for later. Terminal blocks for power and data are located behind this cover.

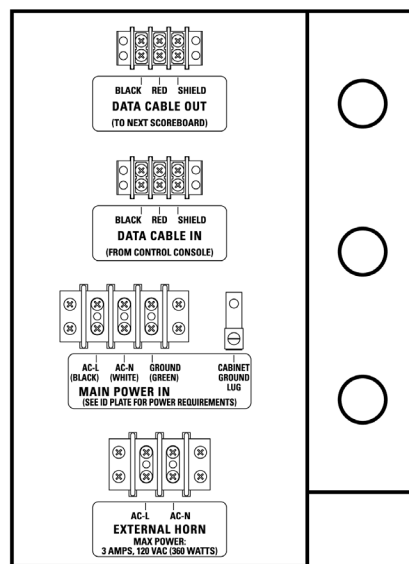
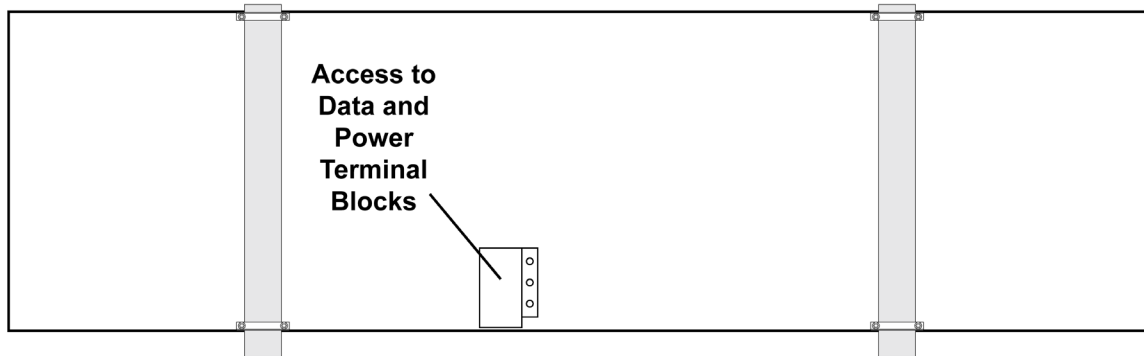

**Step 4: Attach a ground rod.**

A ground rod is required by the National Electric Code (Article 600.7) and is an effective way to make your scoreboard system less susceptible to damage from nearby lightning strikes and other power-related problems. We recommend an (at least) 8-ft. copper ground rod driven into the earth near the scoreboard display. You may attach the wiring from the rod to the outside of the scoreboard cabinet or to the ground lug next to the Main Power terminal.

Although your scoreboard display may be attached to steel posts, the posts do not make good ground rods. Steel will corrode over time. Any finish applied to the steel to slow down corrosion will usually insulate the metal, as will concrete footings.

**Step 5: Bring power to the scoreboard cabinet.**

Bring your AC power cable (via conduit from the disconnect switch mentioned in Step 2) through one of the knockouts in the rear of the cabinet. Make sure your power cable is sized sufficiently to handle the current required by this sign. Attach the wires to the Main Power terminal block. We recommend adding crimp-on fork terminals to the end of each power wire.

Step 6: Bring data to the scoreboard cabinet.

If you've purchased the ScoreLink RF Communications system, your scoreboard display already has a wireless client device installed. Your work here is done; move on to the next step.

If you have chosen to send data to the scoreboard display using cable, bring the data cable (via conduit) through one of the knockouts in the rear of the cabinet. Attach the wires to the Data Cable In terminal block, matching the colors as shown below. We recommend adding crimp-on fork terminals to the data wires.



You may purchase data cable from Electro-Mech, or you may source it elsewhere. We recommend (and supply) cable that is rated for direct burial. It includes two insulated 22 AWG stranded conductors (red and black), along with a non-insulated conductor, all wrapped by a braided or foil shield. This document will discuss, in a few pages, what the other end of this cable is connected to.

You may optionally create a "daisy chain" of displays by running additional cable from the Data Cable Out terminal of this scoreboard display to the Data Cable In terminal of another display.

Step 7: Replace the access panel.

You didn't drop any screws, right?

## Junction Box and Data Cable

If your scoreboard package includes the ScoreLink wireless communication system, your work is done here. Skip to the section about the control console.

Your hard-wired scoreboard package includes a junction box, which you should permanently mount to provide a stable point of termination for the data cable. The idea is to connect the control console to this junction box via a ten-foot patch cable. So the junction box will need to be mounted within ten feet of the position where your scoreboard operator will sit. If you plan to operate the scoreboard system from an enclosure (such as a press box) that will remain dry and clean, you may mount the junction box directly to an interior wall or in some other protected area. If you plan to operate the scoreboard from a position that will be exposed to weather, you should mount the junction box inside a weather-tight enclosure. Exposure to moisture, dirt, etc. will eventually corrode the connection points in the junction box and interfere with signals sent to the scoreboard display.

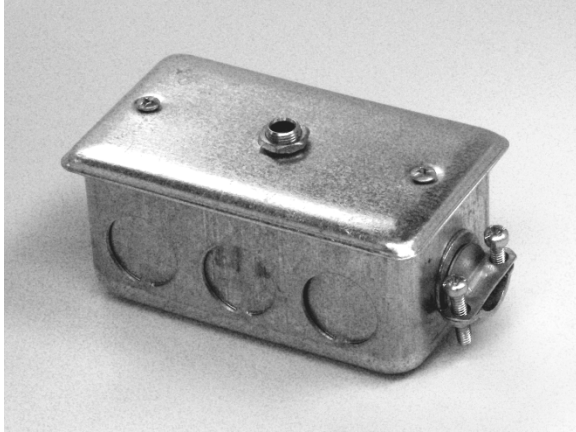

It is a good idea to mount the junction box where it is not likely to be stepped on, tripped over, or kicked. It is also important to label your junction box. The connectors used for scoreboard data look very much like the type used in some audio systems. Plugging audio devices into a scoreboard data line can possibly damage the scoreboard system.

The junction box ships with a length of cable soldered to the stereo socket and tucked inside the box. There should be no need to solder cable to this socket during the installation. Instead, splice the wires from the cable to the pigtail inside the junction box, matching colors. The wires in the pigtail are 22 AWG, and the cable should use the same size conductors. The installer must provide wire nuts, crimp splices, or other means to connect the wires.



The splice point should stay inside the junction box. That is, you want to feed the long run of cable into the box rather than pulling the pigtail out. Electro-Mech provides a strain relief on one side of the junction box to secure the cable. You may choose to connect conduit directly to the junction box, in which case the strain relief will not be needed. The junction box is designed to accept 3/4-inch conduit fittings.

We recommend running data cable in conduit from the junction box to the scoreboard display – especially where the cable would otherwise be exposed. You should never run data cable in the same conduit as power cable. Having more than one run of scoreboard data cable in a single conduit is perfectly fine.

One more warning about data cable: Never split or branch the cable. The current loop signal we use to transmit data to our scoreboard displays will behave unpredictably if it is divided between two destinations. There are other options for getting synchronized data to two locations, including daisy chaining from one scoreboard display to the next. If your facility calls for a more complicated cabling plan, it is best to work out the details with your scoreboard sales rep prior to installation.

## Connections at the Control Console

The standard control console packaged with this scoreboard system is powered through a typical three-prong AC power cord. At the point of operation, the console requires a grounded power receptacle.

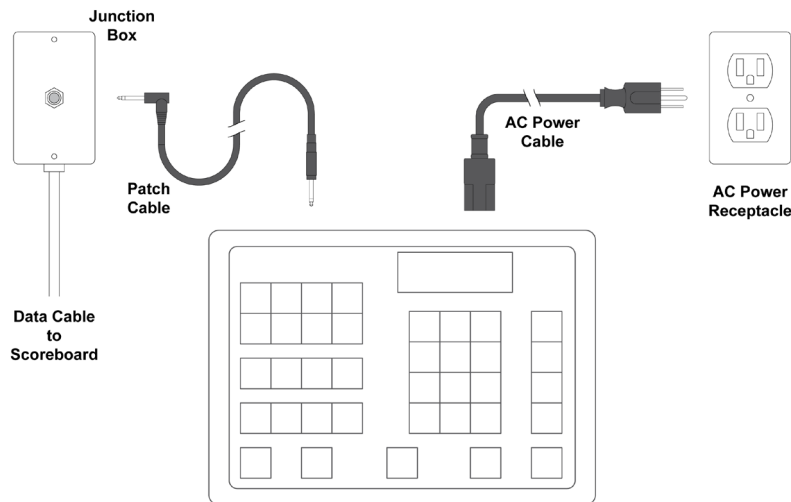

If your scoreboard package includes a ScoreLink RF Communications system, the power receptacle may be the only consideration on the control console side of the installation process. For details about ScoreLink, consult the documentation that ships with the product. Otherwise, use the stereo patch cable to plug the console into the junction box.

## TESTING, OPERATION, AND ONGOING CARE

After all power, data, and other connections are in place, it is time to test the scoreboard system. Apply power to the scoreboard display first. Although there is no harm in powering the control console first, the illuminated digits and indicators on the sign will remain blank if the scoreboard display receives power before it receives data. Any LEDs (other than Electronic Team Names, which will initially power up with GUEST and HOME showing) that are illuminated on the sign in this condition would indicate a problem at the scoreboard display.

Next, power up the control console and, for wired setups, connect one of its data output ports to the junction box using the stereo patch cable. The scoreboard display should begin showing data within a few seconds. Make sure buttons on the control console produce responses at the scoreboard display. You may need to consult the documentation that ships with the control console to test certain features.

For scoreboards with Clock features, set the Clock to count down the final 30 seconds of a Period. If your scoreboard includes a Horn, it will (by default) sound when the Clock reaches 0.

### **Scheduled Testing and Maintenance**

The scoreboard system does not require scheduled maintenance procedures. However, it is important to check for problems prior to a game. We recommend running through the tests described above between two and four weeks prior to the start of a season (or anytime you plan to use the scoreboard after a gap of more than a month). During the season, test out the scoreboard the day before each game.

### **After the Game, and After the Season**

Whenever you are not using your scoreboard system, use the disconnect switch to cut power to the sign. You should unplug the control console from its power source and from the data cable as well. It is not necessary to take steps beyond this, even if the scoreboard will not be used for several months.



## MAINTENANCE

We hope your scoreboard system provides years of trouble free service. In the event of a problem, the material that follows will provide some information about contacting technical support as well as some details about the parts inside your scoreboard display.

### **Contacting Technical Support**

Our support staff is available via phone or e-mail Monday through Friday 8:00 through 5:00 Eastern. Our web address and phone number is printed at the bottom of this page. When contacting Electro-Mech for support, it helps to have the scoreboard model (**LX6360**) handy as well as the version of the software running on your control console. If your control console includes an LCD display, you will see the software version flash briefly (for about three seconds) on the screen when you first apply power. Whether you have the LCD display or not, you should find on the bottom of the control console a product label which gives the software version.

If you are reading this manual in search of help with a different scoreboard model, for outdoor scoreboards, you can find the model number printed on a metal plate attached to the back of the scoreboard cabinet near where the power enters. For indoor scoreboards, the model number is usually printed on a label at the top center of the cabinet near the attachment point for the power cable.

If you are troubleshooting a problem, the most important information to have is an exact description of which parts of your scoreboard system are working and which parts are not working. The best person to make contact with our support team is someone who has seen the problem first hand. Better yet, give us a call when you are there at the scoreboard display and can walk through a few simple tests with one of our technicians.

Scoreboard problems are rarely so complicated that diagnosing them requires skills beyond using a screwdriver and a ladder. Similarly, replacing parts is straightforward process that does not require complex tools or special knowledge.

## Parts Exchange

If, after working with our support staff, you discover that a part needs to be serviced or replaced, the next step is to send the part to Electro-Mech for repair. During the warranty period, we repair parts and return them via UPS ground service at no charge. We can ship parts via overnight service for an additional charge. For work that falls outside of the warranty terms, we can, upon request, provide an estimate of repair costs on returned parts before performing the work. The typical turnaround on repair work is less than three business days

Electro-Mech maintains a supply of common parts for immediate shipment. Some customers choose to purchase new parts for immediate use and will later send old parts back to us to be repaired and returned as "backup" stock. In some cases our support plans include the option for shipping replacement parts to the customer once our service staff has identified a problem. The customer will then return the damaged part after receiving the replacement. Electro-Mech requires a valid credit card number before initiating a shipment of this type. We do not apply charges to the card unless the customer does not return parts within ten days or if the returned parts require work outside of our warranty terms.

Our shipping address:

Electro-Mech Scoreboard Co.  
72 Industrial Blvd.  
Wrightsville, GA 31096

## Location of Serviceable Parts

The power and driver components are located behind the Score digits on the right side of the scoreboard cabinet. This is typically the Home Score position. If your scoreboard includes a ScoreLink RF receiver unit, it will be accessible just to the left of the same Score digits. If your scoreboard includes Electronic Team Names, power and driver components for both teams are located behind the ETN display on the right side.

The internally mounted Horn is positioned in the lower left corner of the cabinet. It is attached to a plate that can be removed from the face of the scoreboard display. The next section of this document discusses removing and replacing illuminated PCB assemblies.

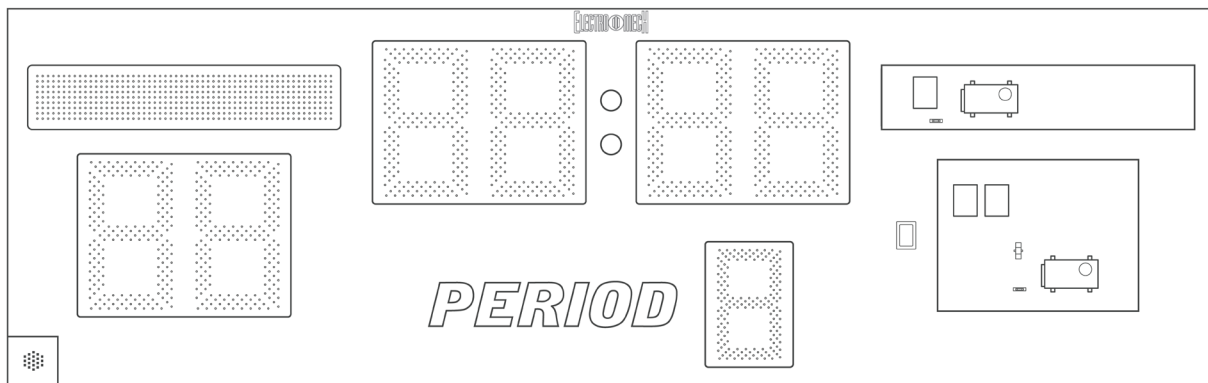

## Illuminated PCB Assemblies

The LED assemblies and circuit boards (but not individual LEDs) are field replaceable parts. Each LED is soldered to a printed circuit board (PCB) which is, in turn, attached to a protective metal mask. The mask assembly is attached to the scoreboard face with self-tapping screws. You will need a 1/4-inch nut driver to remove these screws.

### Removing an LED Assembly, Step-By-Step:

- Disconnect power to the scoreboard cabinet before performing any service work.
- Remove the self-tapping screws from the metal mask, leaving for last one of the screws along the top of the mask.
- Support the mask with one hand as you remove the final screw.
- Rotate the mask so that you can see the PCB (or PCBs) behind it and the cable connections along the back side.
- Unplug the ribbon cables, and, if present, the power cables from the PCBs.
- Set the LED assembly aside and save the screws for later.

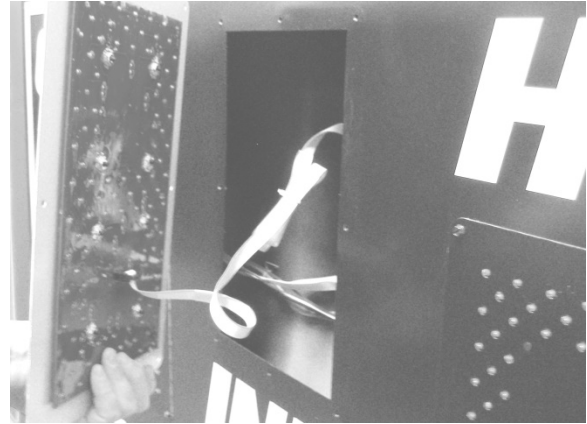

If your purpose in removing the LED assembly was to provide access to the components behind it, you may skip the next part about removing and replacing the LED printed circuit board.



The LED circuit board is held to the mask by several nuts, which you can remove using a 3/8-inch nut driver. On outdoor displays the thick conformal coating can be messy, as the lock washers on the nuts dig into the coating and knock pieces of it away. Some single digit PCBs fit into their masks in two orientations, 180 degrees apart. Unless the digit shares the mask with another PCB, either orientation is fine within the mask. But you have to be careful to keep the whole assembly right side up when you return it to the scoreboard cabinet.

## Power Supplies and Fuses

AC power enters the scoreboard display at the power terminal block in the back of the cabinet. From this terminal block, power is routed through the power system in the sign. The line side of AC passes through a 5-amp fuse on the way to the main power supply, which is located behind the Score digits on the right (typically Home) side of the cabinet. If your scoreboard includes Electronic Team Names, you will find a 10-amp fuse behind the ETN section on the right side. This fuse protects the power supply for the ETNs. Both fuses are AG style and should only be replaced with fuses of the same style and rating.

Power connections are made along a row of screw terminals on one side of each power supply module. A Mean Well RSP-320-24 power module provides 18.9 VDC to the illuminated digits and indicators along with their drivers. The ETNs, if present, use a Mean Well RSP-500-5 power module set to deliver 5 VDC. If you replace either of the power supply modules, check the output voltage to make certain it is set correctly.



## LX Drivers

The LX Driver circuit boards do the work of interpreting data sent from the control console to the scoreboard display. Using that information, the drivers decide which of the LEDs should be illuminated and which should not. Each LX Driver in this system decodes data representing a specific set of digits or other indicators used in the scoreboard. The drivers send signals to the LED circuit boards via ribbon cables.



Data flows from one LX driver to the next in order, starting at the lower chassis (if there is more than one), and then left to right within each chassis. In the table(s) below, columns identify the LX Drivers, listed in order, left to right, based on the data path. The table rows give the names and purposes of the various connectors on the LX Drivers.

Connector	LX17	LX22
J2 (Data In)	From ScoreLink	
J3 (Data Out)	To LX22	To Data Out Terminal Block or ETN1 driver
J4 (Word 1 Low)	Period Clock Minutes Ones	Right (Home) Score Ones
J5 (Word 1 High)	Period Clock Minutes Tens	Right (Home) Score Tens
J6 (Word 2 Low)	Period Clock Seconds Ones	Left (Guest) Score Ones
J7 (DC Power In)	18.9 VDC	18.9 VCD
J8 (Word 3)	Period	
J9 (Word 2 High)	Period Clock Seconds Tens	Left (Guest) Score Tens
J10 (Word 4)		
J15	Horn Relay	
H5/BLK (Data In)	From cable	From LX17
H6/RED (Data In)	From cable	From LX17
H7/SHLD (Data In)	From cable	From LX17
Jumper Pins	LX17	LX22
H13 (J4/J5 Blanking)		
H16 (J4/J5 Blanking)	X	X
H14 (J6/J9 Blanking)		X
H17 (J6/J9 Blanking)		
H15 (Not Used)		
H18 (Test Prog)		
H3 (Horn2 No Dim)	X	X
H11 (Horn1 No Dim)	X	X
H19 (Not Used)		
H1 (Memory Ret.)		
H2 (Group +1)	X	X
H4 (Bank +2)		X
H12 (Bank +1)	X	

If your scoreboard includes Electronic Team Names, the ETN1 driver will be located behind the ETN section on the right side. The J14 connector supplies ETN data to the section on the right side. The J10 connector supplies ETN data to the other display.

## LIMITED WARRANTY STATEMENT

**Electro-Mech Scoreboard Company  
Standard Equipment Warranty and Limitation of Liability  
for Scoreboards and Accessories Sold in the United States**

### **Warranty Coverage**

Electro-Mech warrants to the original end-user that the Equipment will be free from Defects (as defined below) in materials and workmanship for a period of five years from the date of invoice. Electro-Mech's obligation under this warranty is limited to, at Electro-Mech's option, replacing or repairing any Equipment or Part thereof that is found by Electro-Mech not to conform to the Equipment's specifications. Any defective Part must be returned to Electro-Mech for repair or replacement. Equipment determined not to conform to specifications will be repaired or replaced and returned to purchaser with standard ground service transportation charges prepaid. Replacement Parts or Equipment will be new or serviceably used, comparable in function and performance to the original Parts or Equipment, and warranted for the remainder of the warranty period. Purchasing additional Parts or Equipment from Electro-Mech does not extend this warranty period.

Defects shall be defined as follows. With regard to the Equipment (excepting LEDs), a "Defect" refers to a material variance from the design specifications that prohibits the Equipment from operating for its intended use. With respect to LEDs, "Defects" are defined as LEDs that cease to emit light. The limited warranty provided by Electro-Mech does not impose any duty or liability upon Electro-Mech for partial LED degradation.

This limited warranty is not transferable.

### **Exclusions from Warranty Coverage**

The limited warranty provided by Electro-Mech does not impose any liability upon Electro-Mech for:

- Damage caused by the unauthorized adjustment, repair, or service of the Equipment by anyone other than personnel of Electro-Mech or its authorized repair agents.
- Rental fees or other costs associated with lifts, cranes, or other tools and services used to access the Equipment.

- Damage caused by the failure to provide a continuously suitable environment, including, but not limited to (i) neglect or misuse (ii) a failure or surges of electrical power (iii) any cause other than ordinary use.
- Damage caused by vandalism, fire, flood, earthquake, water, wind, lightning, or other natural disaster, or by any other event beyond Electro-Mech's reasonable control.
- Costs associated with replacement of communication methods including but not limited to, wireless systems, copper wire, fiber optic cable, conduit, or trenching for the purpose of overcoming local site interference.
- Any statements regarding products or services made by salesmen, dealers, distributors, or agents, unless such statements are in a written document signed by an officer of Electro-Mech.

### **Limitation of Liability**

In no event shall Electro-Mech be liable for any special, consequential, incidental, or exemplary damages arising out of or in any way connected with the Equipment or otherwise, including but not limited to damages for lost profits, cost of substitute or replacement equipment, down time, lost data, or injury to property, or any damages or sums paid by the purchaser to third parties.